



SHARLIGHT ELECTRONICS CO., LTD.

SPECIFICATION FOR APPROVAL

Part No. : SLE-4444NP40-1.5WCJZ

Package Dimensions

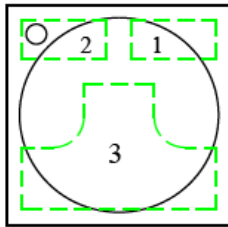
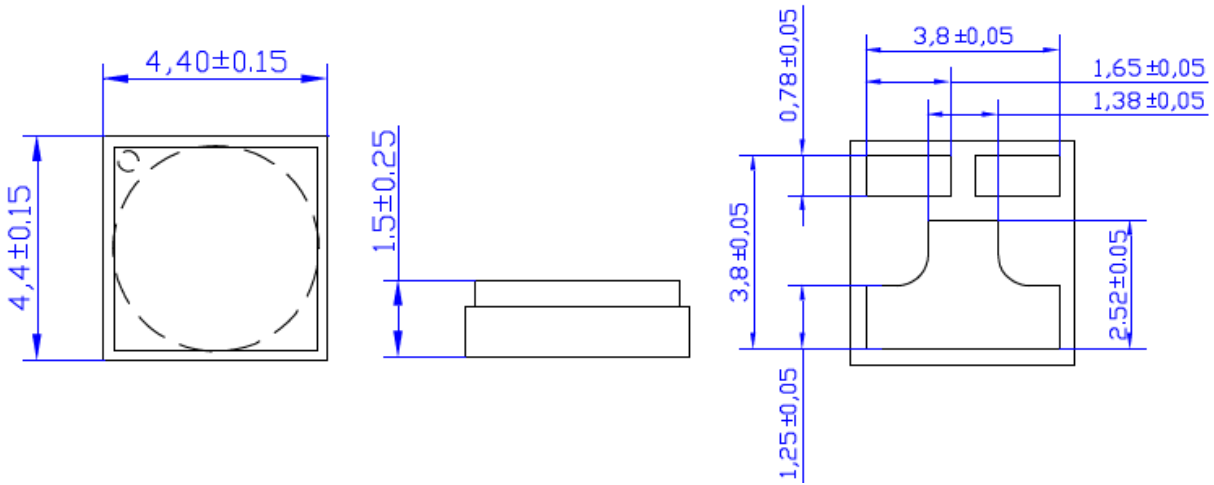

TOP

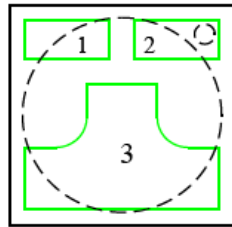

BOTTOM

PAD	Function
1	Cathode
2	Anode
3	Thermal

Fig. Pad configuration.

Recommended Solder Pattern

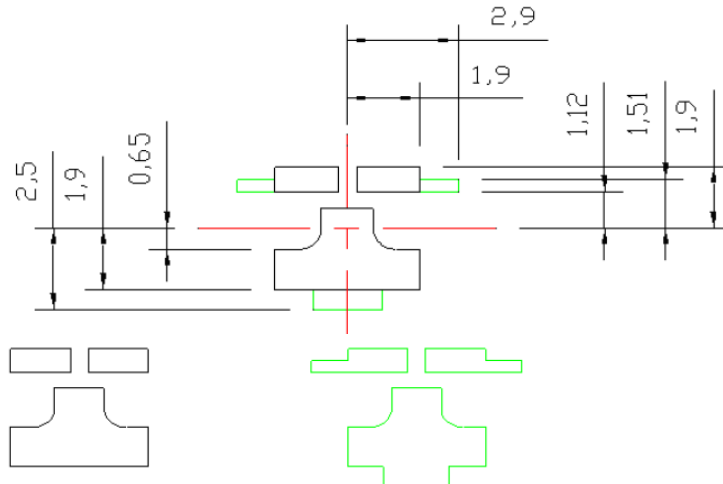

SOLDER
MASK

COPPER
LAYER

Part NO.	Lens	Emission Color
SLE-4444NP40-1.5WCJZ	120° Beam Angle	Deep UV



SHARLIGHT ELECTRONICS CO., LTD.

SPECIFICATION FOR APPROVAL

Part No. : SLE-4444NP40-1.5WCJZ

Features <ul style="list-style-type: none"> ■ Deep Ultraviolet LED ■ Dimension : 4.4mm(L)×4.4mm(W) ■ All Metal Design Cu Substrate/Al reflector ■ View Angle 120° ■ Low thermal resistance 	Applications <ul style="list-style-type: none"> ■ Disinfection ■ Chemical and Biological analysis
--	--

Absolute Maximum Ratings at Tj=25°C

Parameter	Maximum Rating	Unit
Power Dissipation	1.5	W
Max DC Forward Current	150	mA
Thermal Resistance, Junction-Case	15	°C/W
Operating Temperature Range	-40°C to + 60°C	
Storage Temperature Range	-40°C to + 100°C	
Soldering Condition	260°C For 5 Seconds	

Note:

1. The thermal resistance value is measured with MCPCB (Star).

Electrical / Optical Characteristics at Tj=25°C

Parameter	Symbol	Min.	Typ.	Max.	Unit	Test Condition
Radiant Irradiance	E _e		2.8		mW/cm ²	IF =150mA
Radiant Flux	Φ _e	8	10		mW	IF =150mA
Forward Voltage	V _F		8	10	V	IF =150mA
Peak Wavelength	λ _P	265		275	nm	IF =150mA
Viewing Angle	2θ _{1/2}		120		deg	IF =150mA
Spectra half-width	Δλ		15		nm	IF =150mA

Note :

- 1.Forward voltage measurement allowance is ± 0.2V.
- 2.Radiant flux measurement allowance is ± 10%.
- 3.Irradiance tested at a distance 10mm from Al reflector.
- 4.Wavelength measurement allowance is ± 3nm.

LISTER : 周素華 02-08-17	EDITOR : 02-08-17	DATE : 02-08-17	REV : A
-----------------------	-------------------	-----------------	---------



Part No. : SLE-4444NP40-1.5WCJZ

Characteristic Diagram

Forward Current vs. Forward Voltage

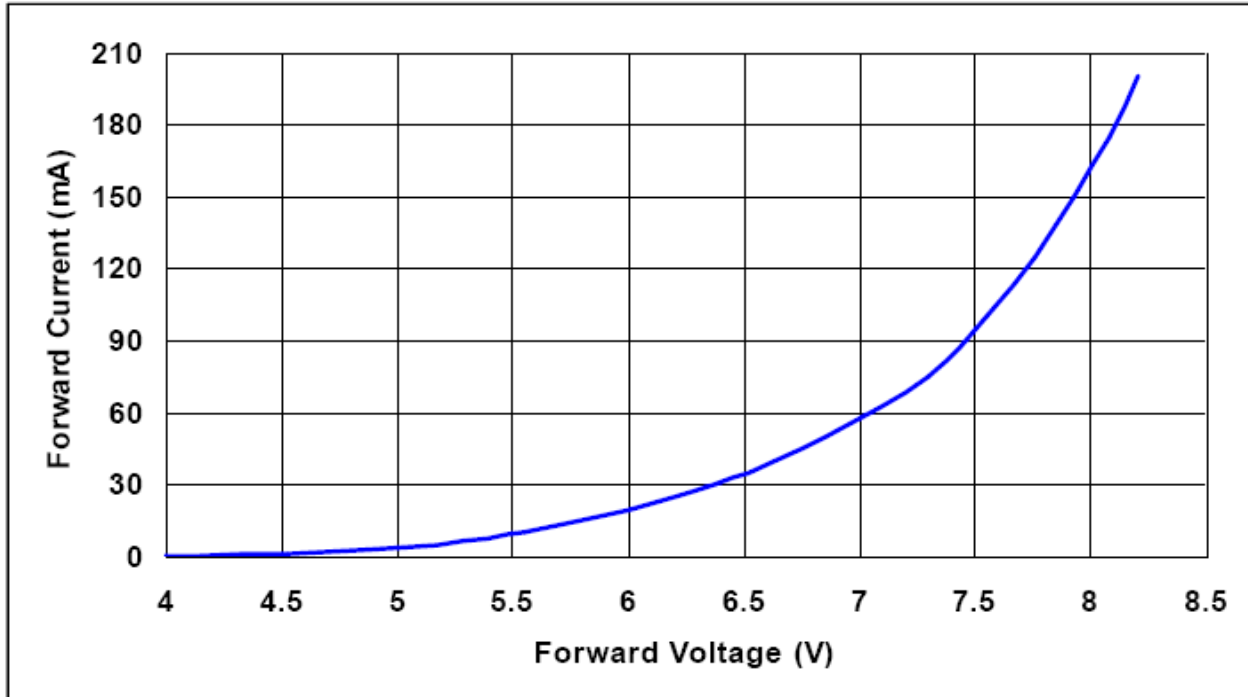

Relative Intensity vs. Forward Current

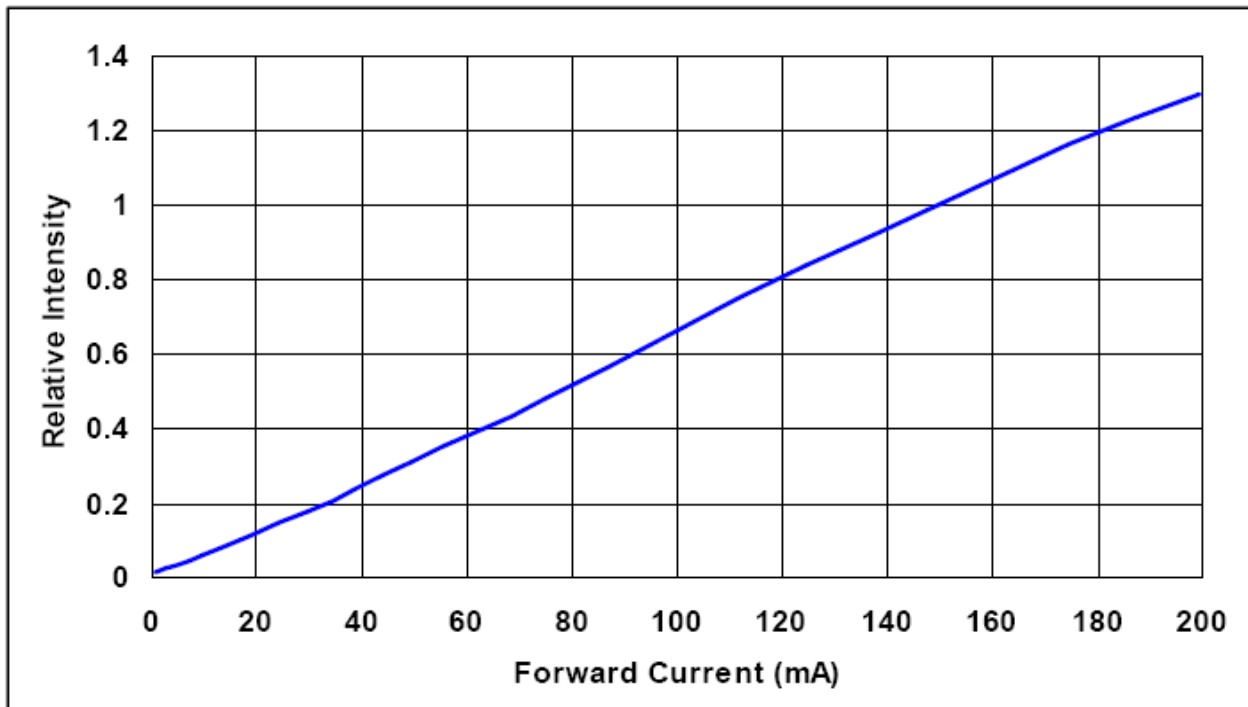



SHARLIGHT ELECTRONICS CO., LTD.

SPECIFICATION FOR APPROVAL

Part No. : SLE-4444NP40-1.5WCJZ

Spectral Power Distribution

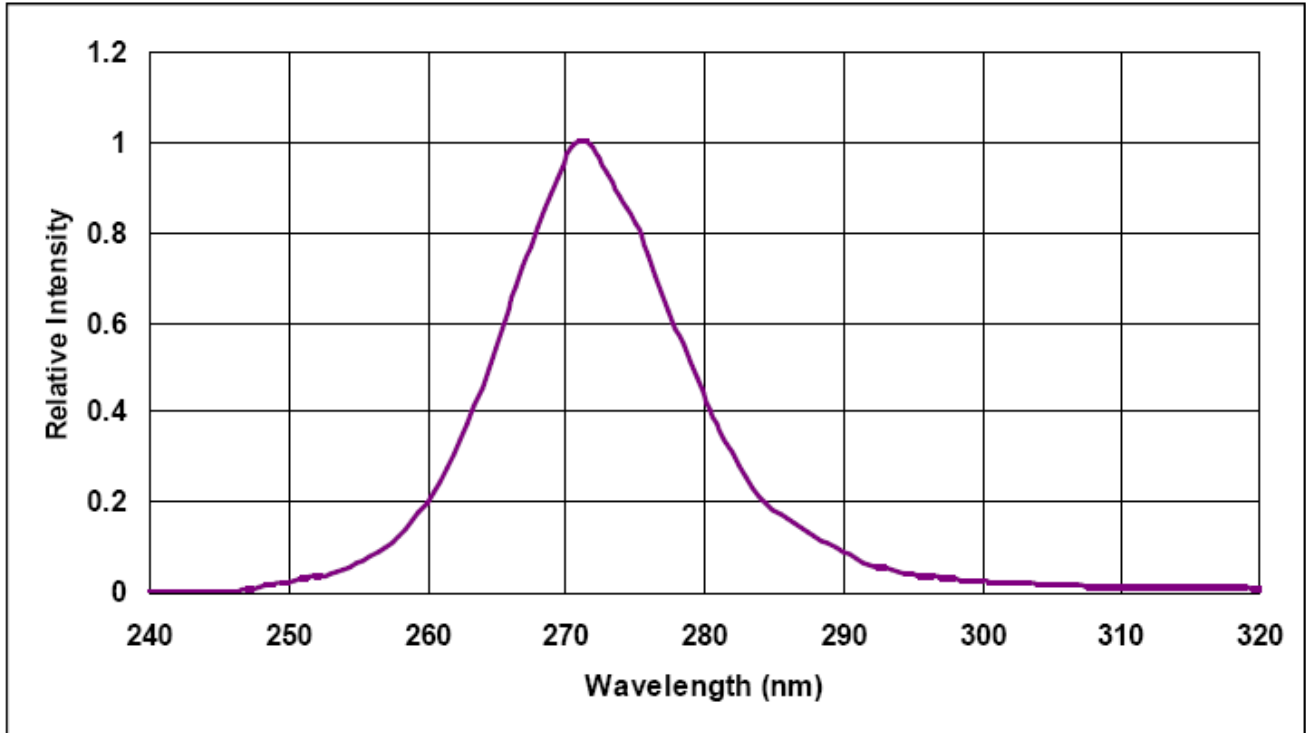

Typical Radiation Pattern

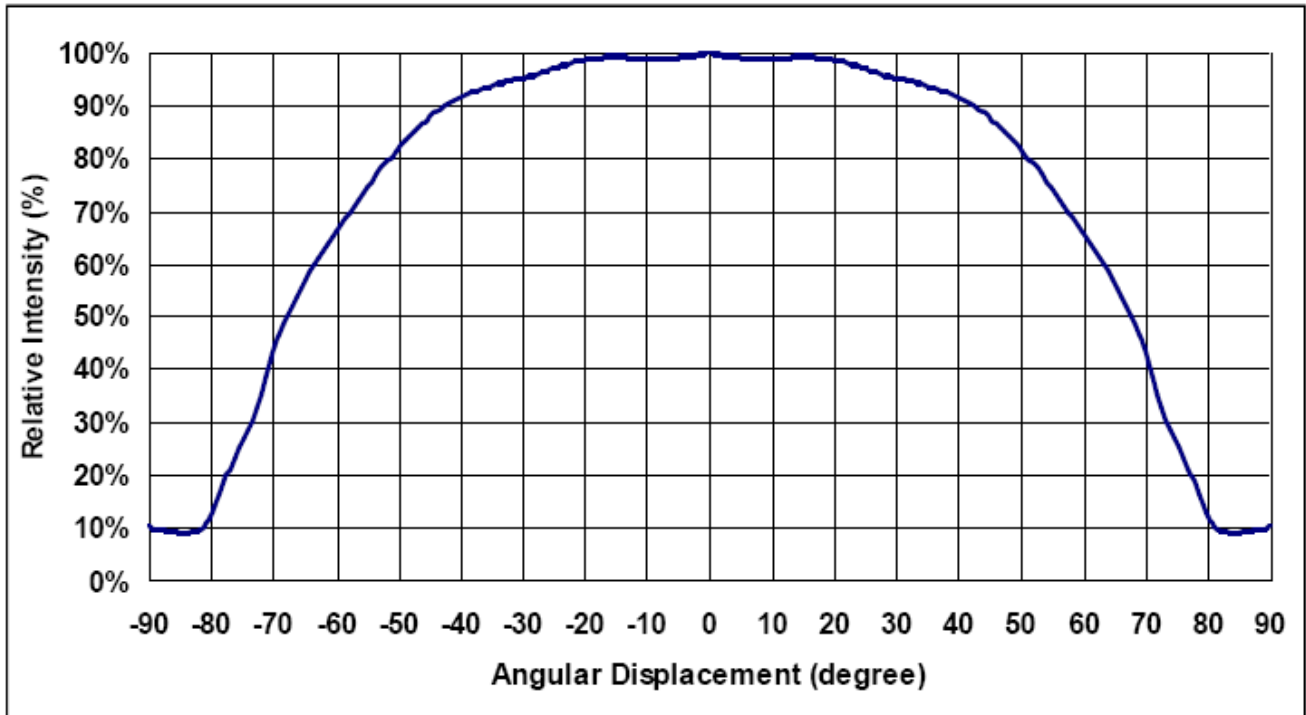



SHARLIGHT ELECTRONICS CO., LTD.

SPECIFICATION FOR APPROVAL

Part No. : SLE-4444NP40-1.5WCJZ

Recommended Solder Profile

Soldering Recommended soldering conditions:

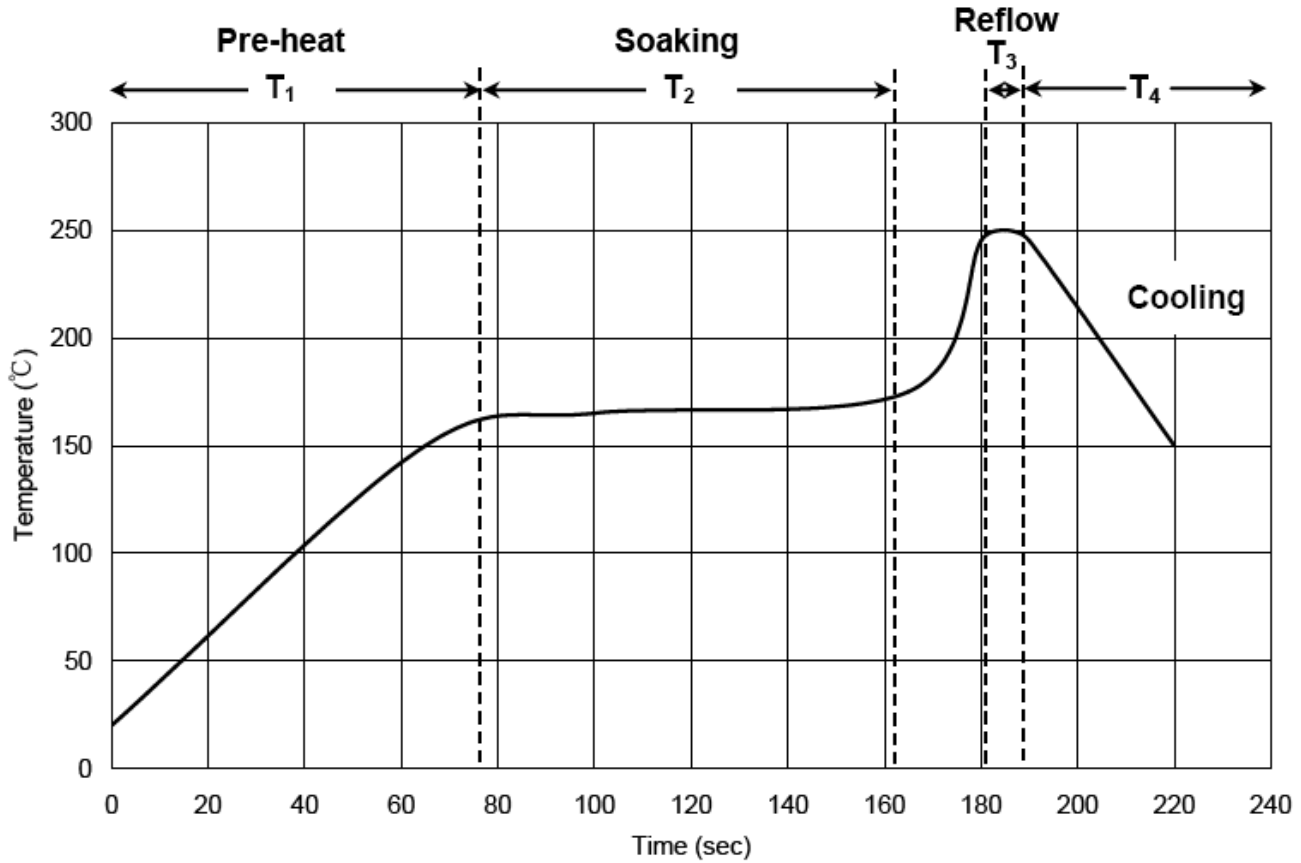

T ₁	Ramp up rate	1.0 ~ 3.0 °C/sec
	Pre-heat time	50 ~ 80 sec
T ₂	Soaking temperature	155 ~ 185 °C
	Dwell time during soaking	60 ~ 120 sec
T ₃	Reflow temperature	240 ~ 250 °C
	Reflow time	Max 10 sec
	Ramp up rate during reflow	1.2 ~ 2.3 °C/sec
T ₄	Cooling	1.0 ~ 6.0 °C/sec

Note: Suggest using Sn96Ag3Cu0.5 lead free solder.

Cleaning

Use alcohol-based cleaning solvents such as isopropyl alcohol to clean the LED if necessary.



SHARLIGHT ELECTRONICS CO., LTD.

SPECIFICATION FOR APPROVAL

Part No. : SLE-4444NP40-1.5WCJZ

Tapping Dimension Packaging Specification

Moisture proof bag. 1 Reel/bag. Q'ty: 800 (MAX)/Reel.

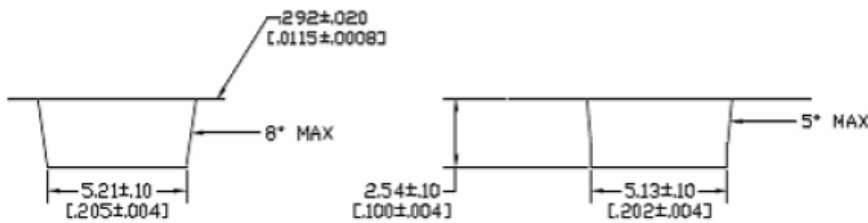
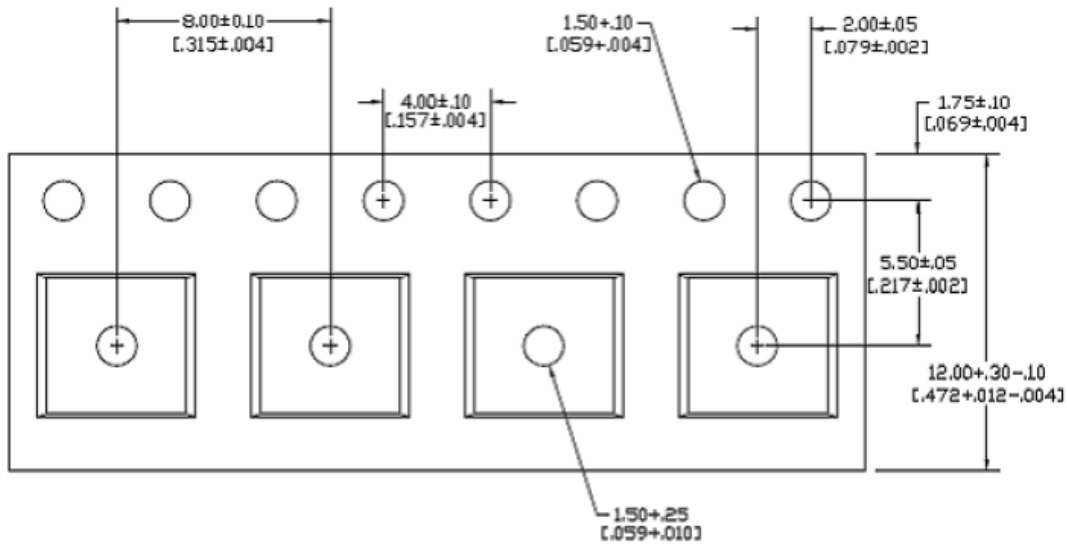

Reel Packaging :

Reel Part :

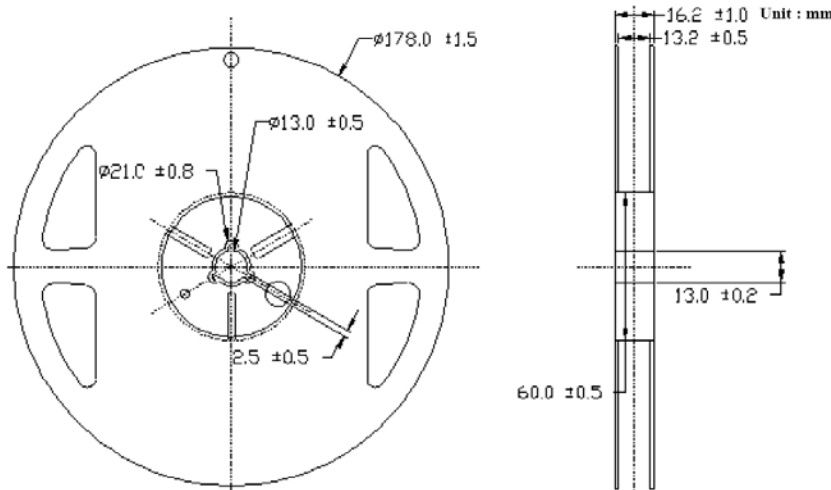

Package

Box Type	Dimension (mm)	Reel/Box	120°Lens Type(Pcs)
Small Box(S)	230x85x265	5 Reel/Box	4000
Middle Box(M)	470x265x270	30 Reel/Box	24000
Large Box(L)	470x435x270	50 Reel/Box	40000

LISTER : 周素華 02-08-17

EDITOR : 02-08-17

DATE : 02-08-17

REV : A